



Ken-Rad

Radio Tubes



ENGINEERING BULLETIN

"THE 6L6 BEAM POWER AMPLIFIER"

CEB 36-8

April 27 1936

THE KEN-RAD CORPORATION ASSUMES NO PATENT LIABILITIES FOR
THE COMMERCIAL USE OF ANY CIRCUITS WHICH ARE SHOWN IN
THIS ENGINEERING BULLETIN.

THE KEN-RAD CORPORATION
INCORPORATED

A DIVISION OF KEN-RAD TUBE & LAMP CORPORATION

OWENSBORO - KENTUCKY



"THE 6L6 BEAM POWER AMPLIFIER"

The Ken-Rad 6L6 is a cathode type power amplifier tube designed for the output stages of radio receivers and audio power amplifiers. This new tube is of all-metal construction and has the operational characteristics of high power output, high power sensitivity, and high efficiency. The power output at all levels has low third and negligible higher order harmonic distortion. The power output and power sensitivity obtainable with a single tube should satisfy the requirements of the less expensive household receivers. The high power output and low distortion features that recommend the 6L6 for service in high quality household receivers and public address amplifiers cannot be obtained in any other tube having comparable power sensitivity. Under the maximum rated conditions two tubes may be operated as a Class AB amplifier to give as high as 60 watts of undistorted power output. The power sensitivity and efficiency obtained at this level makes it easily adaptable to many existing circuit designs using other types of tubes.

The characteristics of the 6L6 are obtained by using an entirely new principle in vacuum tube design. The tube electrodes are so aligned as to focus the electron stream into beams that pass between the screen grid turns. The electron beams are focused so that the space charge of the



beam is an efficient suppressor, eliminating secondary current from the plate. The focusing of the beam also results in a reduction of screen current. The lower screen dissipation increases the overall efficiency obtained. The combined effects produce a tube having high power output, high power sensitivity, and high efficiency.

The inherent distortion characteristics of a single 6L6 are high second with little third and higher order harmonics. Ideal performance is obtained with these tubes in push pull because with this type of operation the second and other even harmonics are cancelled leaving only a small per cent of third and higher order harmonics. The second harmonic obtained in single tube operation may be reduced to a negligible amount by using a triode driver tube that introduces sufficient second harmonic of proper phase to cancel the second harmonic of the output tube. Either single or push pull operation may be used with the output containing an inappreciable amount of distortion.

A commendable characteristic of the 6L6 is its high internal impedance. Because of this high resistance, the power supply need not be as well filtered as for low impedance triodes. In many receivers or amplifiers it will be possible to obtain the supply voltage direct from the rectifier tube with only a condenser filter. In small receivers this will be of particular advantage because no filter



choke other than the speaker field will be necessary. In these applications it is recommended that the 6L6 plate supply be obtained direct from the output of the rectifier and that the receiver load be connected so that it will be filtered by the speaker field. The screen supply should also be well filtered and have good regulation.

The high plate resistance classifies the tube as a constant current amplifier. This can be verified by the characteristic plate current curves of page 13. The individual plate current curves are practically horizontal and extend from low plate voltage values to extremely high plate values. Dynamically, this means that for a low signal amplitude, the load current is constant for any load resistance. At low levels with a reactive load, such as a speaker, the high frequency components of a program signal are accentuated. An output tube having this characteristic can be used in selective radio receivers to compensate for the loss of high frequency audio components that results from sideband cutting in the radio and intermediate frequency amplifiers.

The 6L6 can be used in many classes of audio service and will have particular advantages for each class. On pages 10, 11, and 12 are ratings and characteristics for several types of operation and on pages 13 to 22 are operation curves showing characteristics for several of the typical ratings.



Two types of curves are shown for the Class A ratings and for the Class AB operation that is restricted to negative grid regions. For these classes one curve sheet shows how the power output, harmonics, and plate and screen currents vary with change in load resistance and an additional curve shows how these characteristics vary with input signal volts. For the Class AB ratings that operate in positive grid regions the driver transformer turn ratio was made the independent variable and curves were made using several types of drivers. An additional curve, with the signal volts as the independent variable, is also shown for this type of operation. In most cases the curves are self-explanatory and should be interpreted easily. The circuit diagrams provided on the individual curve sheets and on page 22 show the circuit connections used in the making of the curves.

Single tube operation characteristics are shown on page 14. The curves were made with a bias of -14 volts and a plate and screen potential of 250 volts. The curve with the load resistance as the independent variable shows that at full output the power output curve is relatively flat. At the optimum load of 2500 ohms, the power output is nearly maximum and the third harmonic is very low. The second harmonic although appreciable may be greatly reduced by using a triode driver that produces some second harmonic which will cancel part of the second harmonic of the output tube. The curve



with the signal voltage as the variable indicates how the distortion and power output vary with signal. This curve should be beneficial in the design of a single-ended amplifier.

Measurements were made on the types 6Q7 and 6R7 as drivers to determine the conditions necessary to develop sufficient second harmonic to cancel the second harmonic of a 6L6. Optimum conditions were selected and the curves of page 15 show that the result is very satisfactory. With the 6Q7 driver, a signal of .4 volt RMS drives the 6L6 to rated output with a total harmonic distortion of less than five per cent. A signal of 1.8 volts RMS was necessary with the 6R7. Output and distortion were similar for both systems. Other drivers may be used with similar results. To obtain complete cancellation of the second harmonic the signal to the 6L6 grid must be exactly 180° out of phase with the signal to the preceding tube, and must contain a second harmonic of percentage magnitude equal to that generated within the output tube. Inductive grid loads cannot be used and coupling condensers in resistance capacity networks must be of ample size.

The push pull Class A curves of page 16 are typical curves of 6L6 operation. With the optimum load of 5000 ohms the curves with the signal voltage as the variable show a maximum power output of 15 watts with a third harmonic of only 2%. Fifth and higher order harmonics are negligible.



The Class AB operation characteristics of the tube in negative grid regions recommend the 6L6 for service in public address systems. With maximum voltages a power output of 34 watts is obtainable with a distortion of only 2%. An advantage of this type of operation is the high input resistance to the 6L6 grids. Resistance coupled drivers may be used provided the maximum specified resistance in the grid return is not exceeded. If the maximum value of grid return resistance is used the filament voltage should never exceed rated value by more than 10%. Two curves on page 17 were taken with the load resistance as the variable and show Class AB operation characteristics for this type of operation.

One curve is with screen and plate voltages of 250 and 400, and one with screen and plate voltages of 300 and 400 respectively. An optimum load resistance of 8500 ohms is indicated on the low voltage curve. With this load the power output is 26.5 watts with a 2% third harmonic. The curve taken with the screen potential equal to 300 volts shows a power output of 35 watts with a third harmonic of only 2%. With a load resistance of 3800 ohms the third harmonic is .6 per cent and the power output 24.8 watts.

Two Class AB ratings, requiring power drivers, are given for this tube and should be adaptable to public address systems. With a screen voltage of 250 and a plate of 400



a power output of 60 watts can be obtained with a signal input power of 350 milliwatts. Curves are shown on pages 18, 19, and 20 for the 40 watt condition with the respective drivers 6C5, 6R7, and 6F6 triode. On each sheet a curve is shown with the interstage transformer turn ratio as the variable. For each turn ratio value the signal was adjusted either for 40 watts output or to the point at which grid current started in the driver tube. From these curves an optimum turn ratio was selected and a curve taken with the signal voltage to the driver tube as the variable.

The signal voltage curves using the optimum turn ratio show that the distortion characteristics of all systems are nearly alike. At 25 watts output the total distortion is less than 2% on all three systems. The third and higher harmonics rise at this point and at 40 watts output amount to approximately 5% total. The power sensitivity obtained with the 6C5 and 6R7 drivers is much greater than that obtained with the 6F6 triode. With the types 6C5 and 6R7 the driver plate current is lower and the overall power sensitivity is higher.

The curves of pages 21 and 22 show operation characteristics for the 60 watt condition. On page 21 is a curve taken with the interstage transformer turn ratio as the independent variable and using a 6F6 triode as the driver.



For turn ratios smaller than 3.0 the signal is adjusted for 60 watts output. With turn ratios higher than 3 the grid of the 6F6 draws current before full output is reached and it is necessary to limit the signal to the point at which grid current starts.

Two turn ratios were selected and a curve taken with each to show how the characteristics vary with change in signal volts. The curve on page 21 with the signal voltage varied is with a turn ratio of 3.0/1. With this value a maximum power output of 60 watts is obtained with a third harmonic of 7.4%. Higher order harmonics are present in the output levels above 30 watts. These higher harmonics are objectionable but may be tolerable in public address systems.

On page 22 is a curve taken with a turn ratio of 3.7/1. The maximum power output obtained is only 50 watts but the distortion is less than obtained with a turn ratio of 3.0/1. At 50 watts the third harmonic is 3.8%, the fifth harmonic 1.2%, and the seventh .25%. This condition should be suitable for applications requiring high power output with low distortion.

The data in this bulletin do not describe all possible applications of the 6L6 but give information that should



be of benefit in the design of audio systems. The high power sensitivity, and efficiency obtainable suggest its use in other circuits performing specialized functions.



RATING AND CHARACTERISTICS

Physical Characteristics:

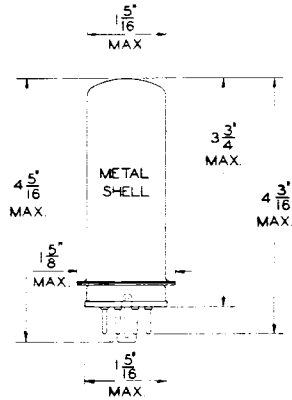
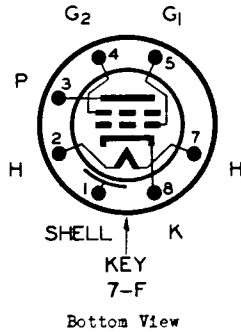

Filament:

Voltage	6.3 Volts
Current	.9 Ampere

Note: Voltage between heater and cathode should be kept at a minimum if direct connection is not possible. Under no conditions should the heater voltage fluctuate so that it exceeds 7.0 volts.

STATIC AND DYNAMIC CHARACTERISTICS

Plate Voltage	250	Volts
Screen Voltage	250	Volts
Grid Voltage	-14	Volts
Amplification Factor	135	
Plate Resistance	22,500	Ohms
Mutual Conductance	6,000	Micromhos
Plate Current	72	Milliamperes
Screen Current	5	Milliamperes

SINGLE TUBE (Class A Operation)

Maximum Conditions:

Plate Voltage	375	Volts
Screen Voltage	250	Volts
°Total Plate and Screen Dissipation	24	Watts

°Provisions should be made that maximum dissipation rating is not exceeded with line voltage variation. Fixed bias values up to 10 per cent of rated screen voltages may be used without increasing distortion.

TYPICAL OPERATION:

FIXED-BIAS

Plate Voltage	375	250	300	375	Volts
Screen Voltage	125	250	200	250	Volts
*Grid Voltage	-9	-14	-12.5	-17.5	Volts
Peak Signal Voltage	8	14	12.5	17.5	Volts
Static Plate Current	24	72	48	57	Milliamperes
Full Signal Plate Current	26	72	55	67	Milliamperes
Static Screen Current	.7	5	2.5	2.5	Milliamperes
Full Signal Screen Current	1.8	7.3	4.7	6.0	Milliamperes
Load Resistance	14,000	2500	4500	4000	Ohms
Total Harmonic Distortion	9	10	11	14.5	Per Cent
Second Harmonic	8	3.7	10.7	11.5	Per Cent
Third Harmonic	4	2.5	2.5	4.2	Per Cent
Power Output	4.2	6.5	6.5	11.5	Watts



SINGLE TUBE (Class A Operation) Continued

TYPICAL OPERATION:

	<u>SELF-BIAS</u>			
Plate Voltage	375	250	300	Volts
Screen Voltage	125	250	200	Volts
*Grid Voltage	** -9	** -13.5	** -11.8	Volts
Peak Signal Voltage	8.5	14	12.5	Volts
Static Plate Current	24	75	51	Milliamperes
Full Signal Plate Current	24.3	78	54.5	Milliamperes
Static Screen Current	.6	5.4	3	Milliamperes
Full Signal Screen Current	2	7.2	4.6	Milliamperes
Load Resistance	14,000	2500	4500	Ohms
Total Harmonic Distortion	9	10	11	Per Cent
Second Harmonic	8	9.7	10.7	Per Cent
Third Harmonic	4	2.5	2.5	Per Cent
Power Output	4	6.5	6.5	Watts

°Provisions should be made that maximum dissipation rating is not exceeded with line voltage variation. Fixed bias values up to 10 per cent of rated screen voltages may be used without increasing distortion.

**With no signal.

*Transformer or impedance coupled input systems are recommended. If resistance coupling is used the DC resistance in the grid return must be limited to .5 megohms for self-biased conditions and .05 megohms for fixed-biased conditions provided that the heater voltage does not exceed rating by more than 10 per cent under all operating conditions.

PUSH PULL CLASS A OPERATION

Maximum Conditions:

Plate Voltage	375	Volts
Screen Voltage	250	Volts
°Total Plate and Screen Dissipation	24	Watts

TYPICAL OPERATION: (All values are for two tubes)

	<u>FIXED-BIAS</u>	<u>SELF-BIAS</u>	
Plate Voltage	250	250	Volts
Screen Voltage	250	250	Volts
*Grid Voltage	-16	** -16	Volts
Signal Voltage (Grid to Grid)	32	35.6	Volts
Static Plate Current	120	120	Milliamperes
Full Signal Plate Current	140	130	Milliamperes
Static Screen Current	10	10	Milliamperes
Full Signal Screen Current	16	15	Milliamperes
Load Resistance (Plate to Plate)	5000	5000	Ohms
Total Harmonic Distortion	2	2	Per Cent
Third Harmonic Distortion	2	2	Per Cent
Power Output	14.5	13.8	Watts

° * ** See notes under "Single Tube Class A Operation"

PUSH PULL CLASS AB OPERATION
(Instantaneous Grid Potential is Never Positive)

Maximum Conditions:

Plate Voltage	400	Volts
Screen Voltage	300	Volts
°Total Plate and Screen Dissipation	24	Watts

TYPICAL OPERATION: (All values are for two tubes)

	<u>FIXED-BIAS</u>				
Plate Voltage	400	400	400	400	Volts
Screen Voltage	250	250	300	300	Volts
*Grid Voltage	-20	-20	-25	-25	Volts
Peak Signal Voltage (G-G)	40	40	50	50	Volts
Static Plate Current	88	88	100	102	Milliamperes
Full Signal Plate Current	126	124	152	156	Milliamperes
Static Screen Current	4	4	5	5	Milliamperes
Full Signal Screen Current	9	12	17	12	Milliamperes
Load Resistance (P-P)	6000	8500	6600	3800	Ohms
Total Harmonic Distortion	1	2	2	.6	Per Cent
Third Harmonic	1	2	2	.6	Per Cent
Power Output	20	26.5	34	23	Watts



PUSH PULL CLASS AB OPERATION (Continued)

TYPICAL OPERATION: (All values are for two tubes)

	<u>SELF-BIAS</u>		
Plate Voltage	400	400	Volts
Screen Voltage	250	300	Volts
*Grid Voltage	** -19	** -23.5	Volts
Peak Signal Voltage (Grid to Grid)	43.8	57	Volts
Static Plate Current	96	112	Milliamperes
Full Signal Plate Current	110	128	Milliamperes
Static Screen Current	4.6	6	Milliamperes
Full Signal Screen Current	10.3	16	Milliamperes
Load Resistance (Plate to Plate)	8500	6600	Ohms
Total Harmonic Distortion	2	2	Per Cent
Third Harmonic	2	2	Per Cent
Power Output	24	30	Watts

° * ** See notes under "Single Tube Class A Operation"

PUSH PULL CLASS AB OPERATION

For full output the grids are driven positive and a power driver is required.

Maximum Conditions:

Plate Voltage	400	Volts
Screen Voltage	300	Volts
°Total Plate and Screen Dissipation	24	Watts

TYPICAL OPERATION: (All values are for two tubes)

Plate Voltage	400	400	Volts
Screen Voltage	250	300	Volts
Grid Voltage	-20	-25	Volts
Peak Signal Voltage (Grid to Grid)	57	80	Volts
Static Plate Current	88	102	Milliamperes
Full Signal Plate Current	169	230	Milliamperes
Static Screen Current	4	6	Milliamperes
Full Signal Screen Current	13	20	Milliamperes
Load Resistance (Plate to Plate)	6000	3800	Ohms
°°Peak Grid Input Power	180	350	Milliwatts
+Total Harmonic	2	2	Per Cent
+Third Harmonic	2	2	Per Cent
Power Output	40	60	Watts

+Obtained with zero-impedance driver.

°°Driver stage should be capable of supplying the grids of the Class AB stage with the specified peak values at low distortion.

°See note under "Single Tube Class A Operation".

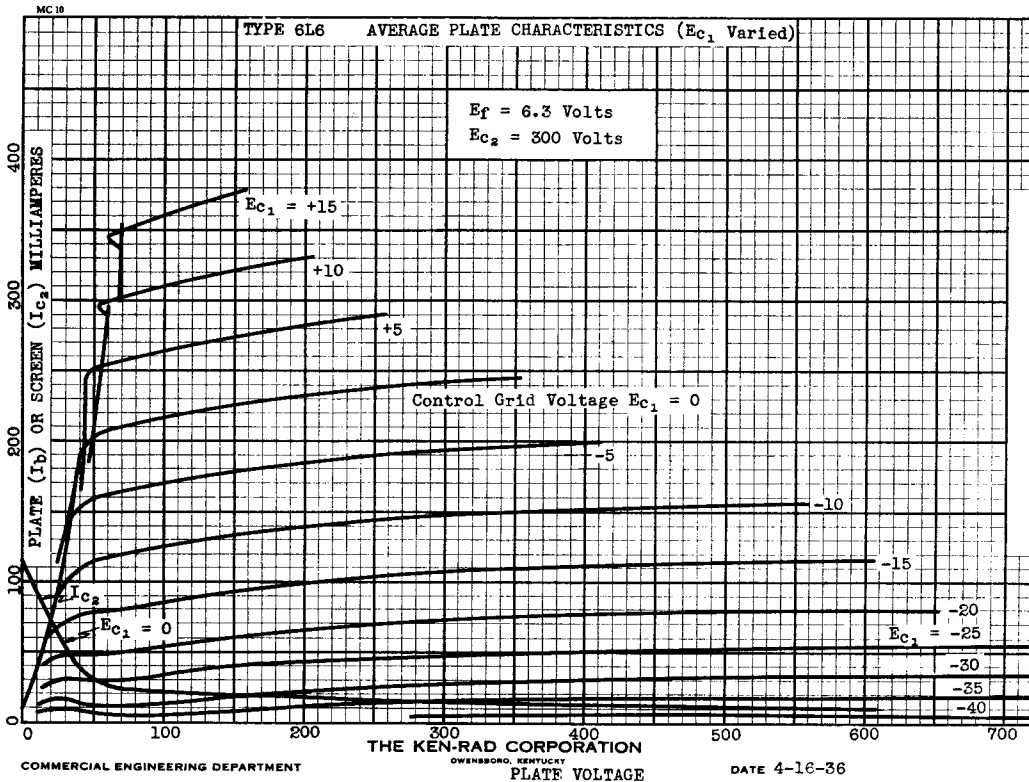
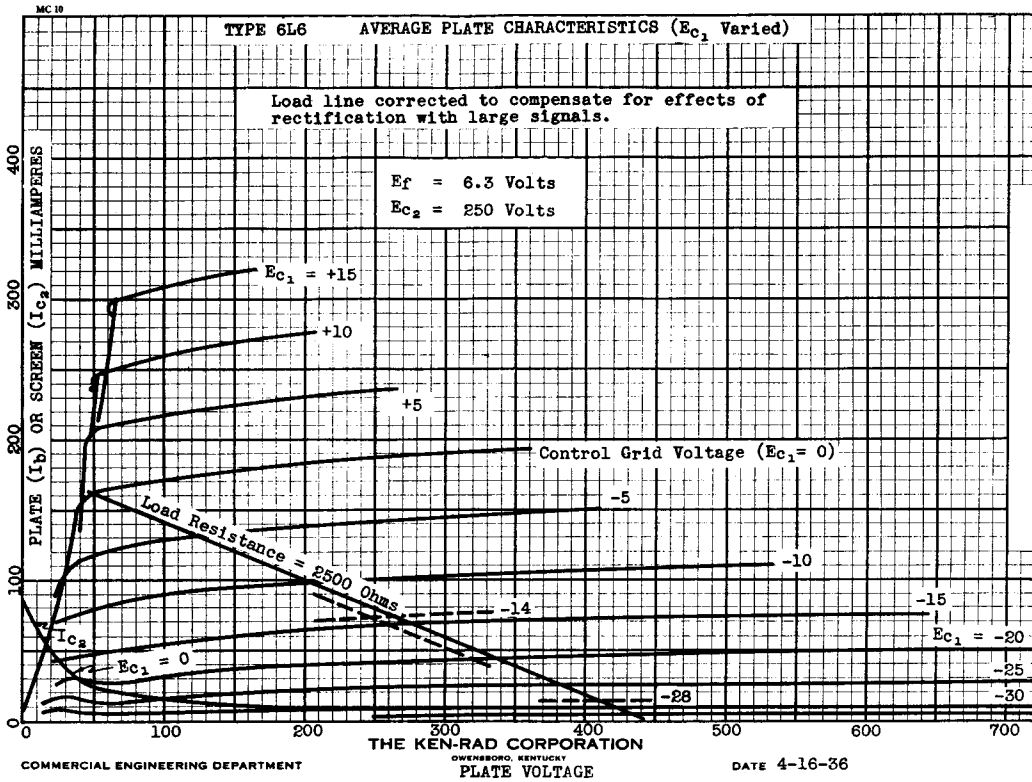

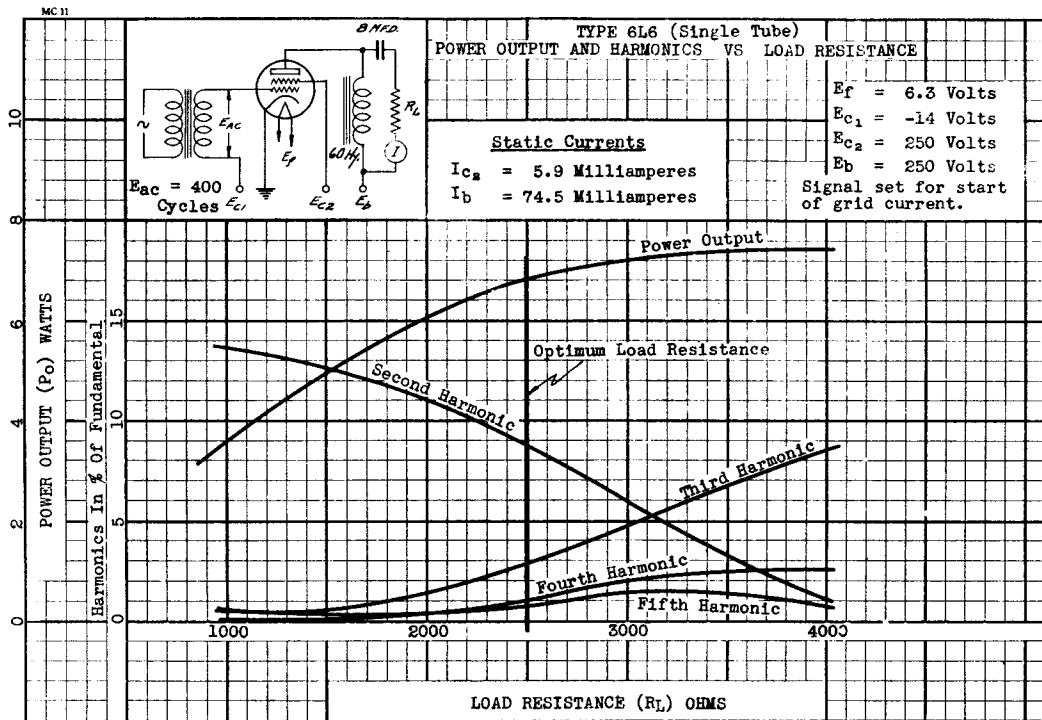

THE KEN-RAD CORPORATION
OWENSBORO, KENTUCKY

COMMERCIAL ENGINEERING DEPARTMENT

DATE 4-16-36

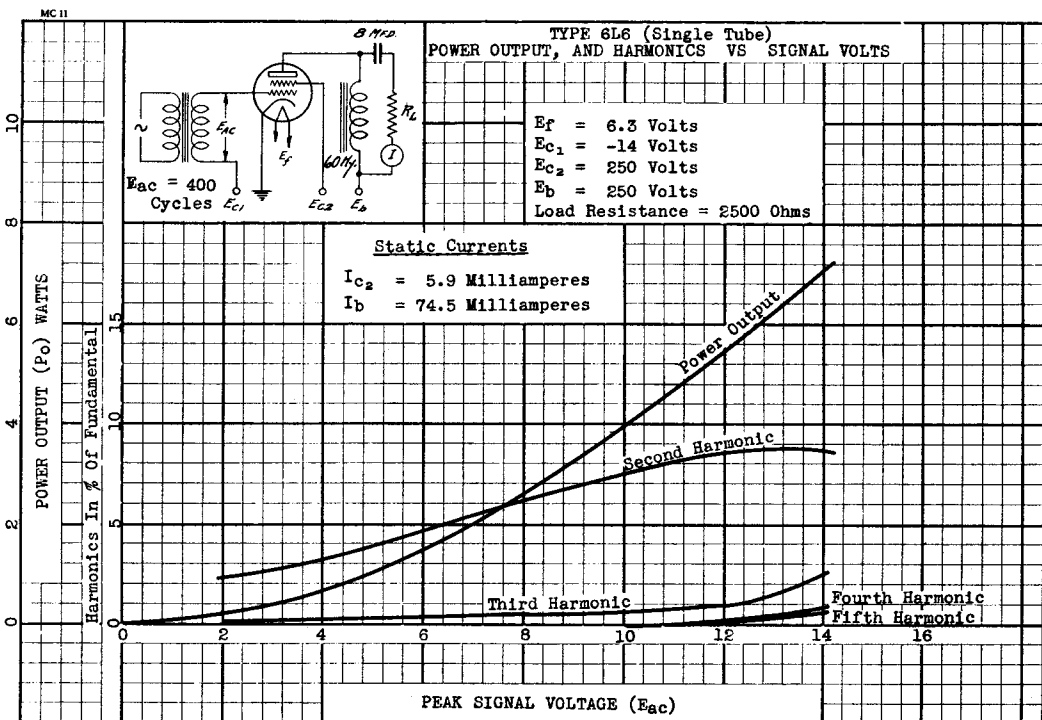

THE KEN-RAD CORPORATION
OWENSBORO, KENTUCKY

COMMERCIAL ENGINEERING DEPARTMENT

DATE 4-16-36

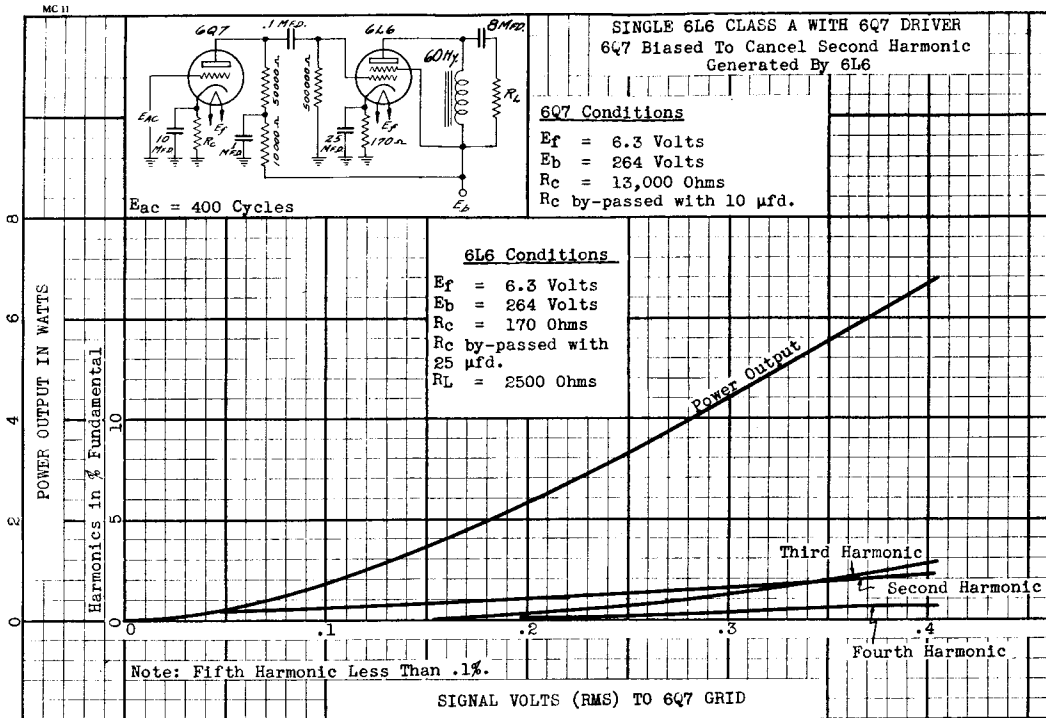

THE KEN-RAD CORPORATION

COMMERCIAL ENGINEERING DEPARTMENT

OWENSBORO, KENTUCKY

DATE 4-16-36

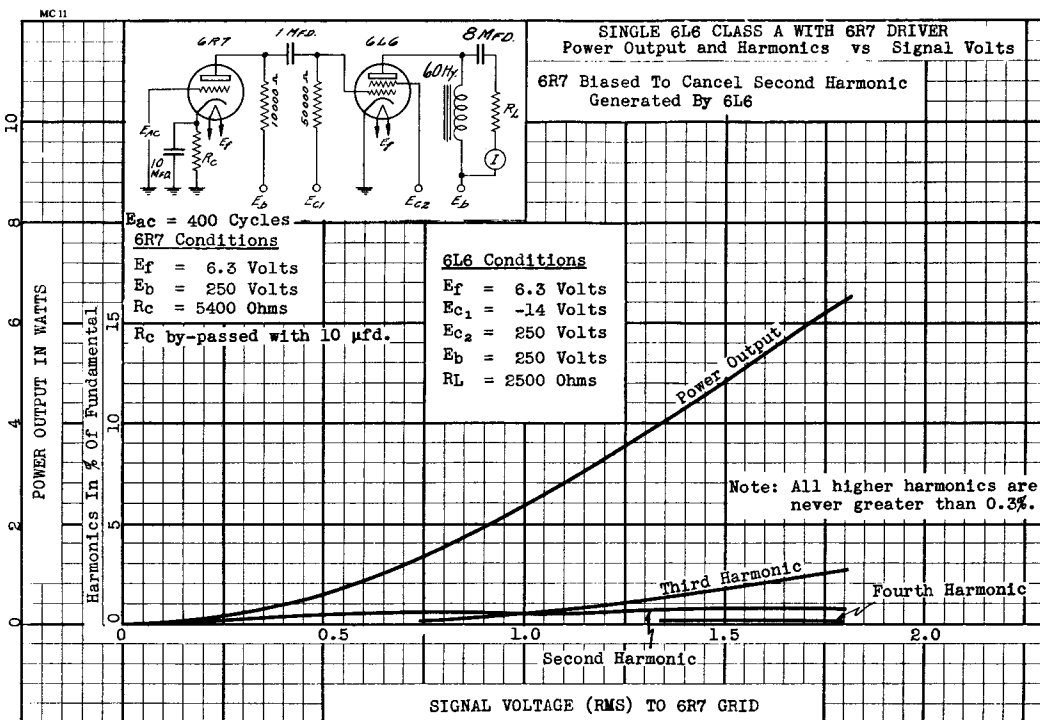

THE KEN-RAD CORPORATION

COMMERCIAL ENGINEERING DEPARTMENT

OWENSBORO, KENTUCKY

DATE 4-16-36

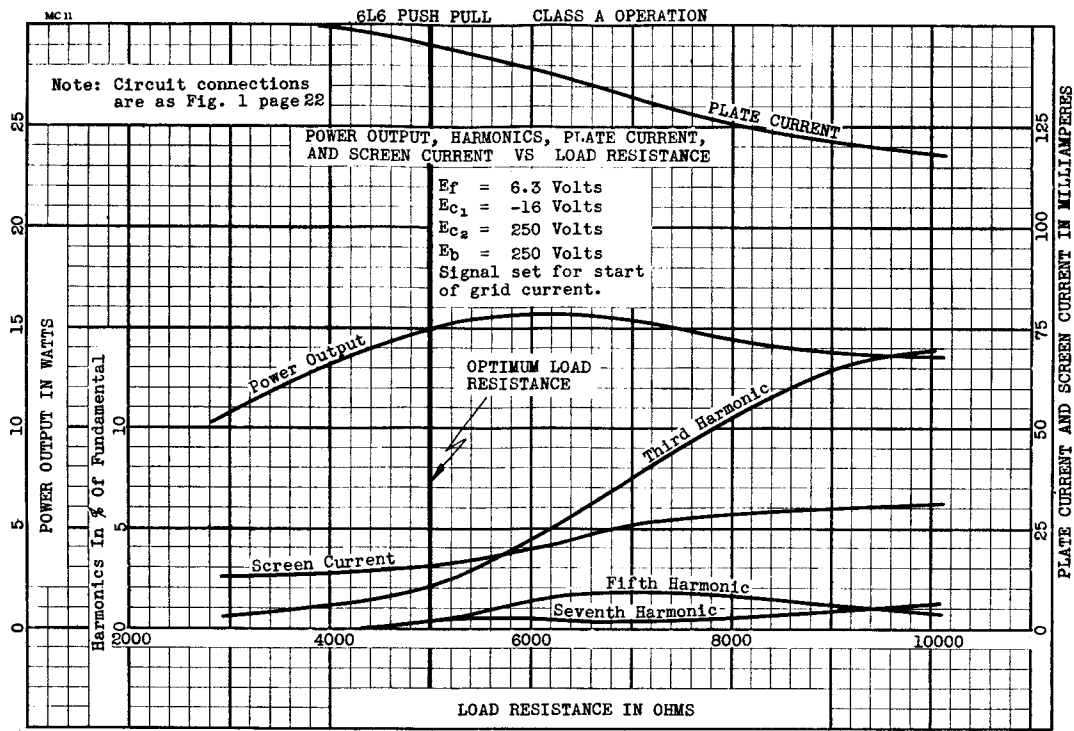

THE KEN-RAD CORPORATION

COMMERCIAL ENGINEERING DEPARTMENT

OWENSBORO, KENTUCKY

DATE 4-16-36

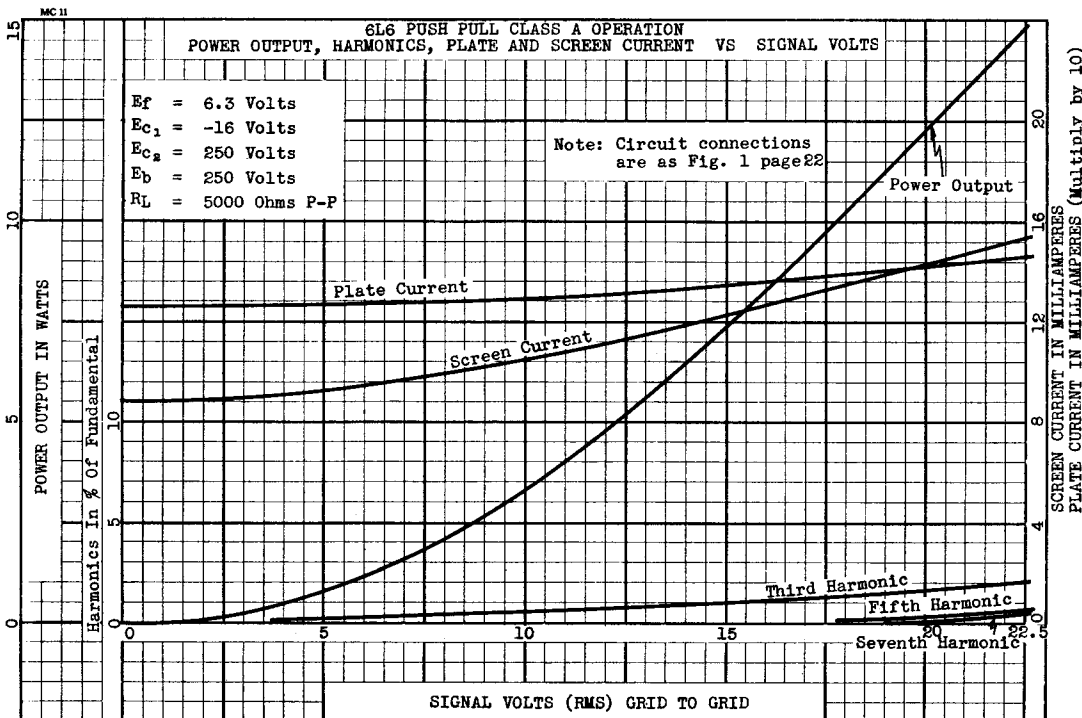

THE KEN-RAD CORPORATION

COMMERCIAL ENGINEERING DEPARTMENT

OWENSBORO, KENTUCKY

DATE 4-16-36

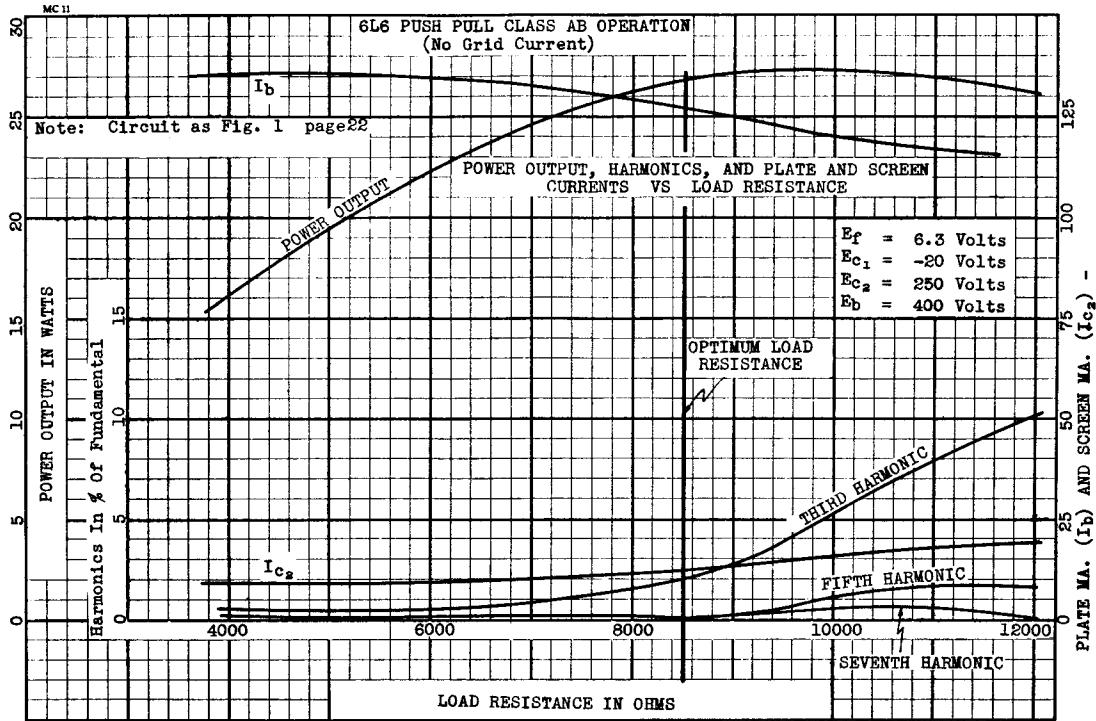

THE KEN-RAD CORPORATION
OWENSBORO, KENTUCKY

COMMERCIAL ENGINEERING DEPARTMENT

DATE 4-16-36

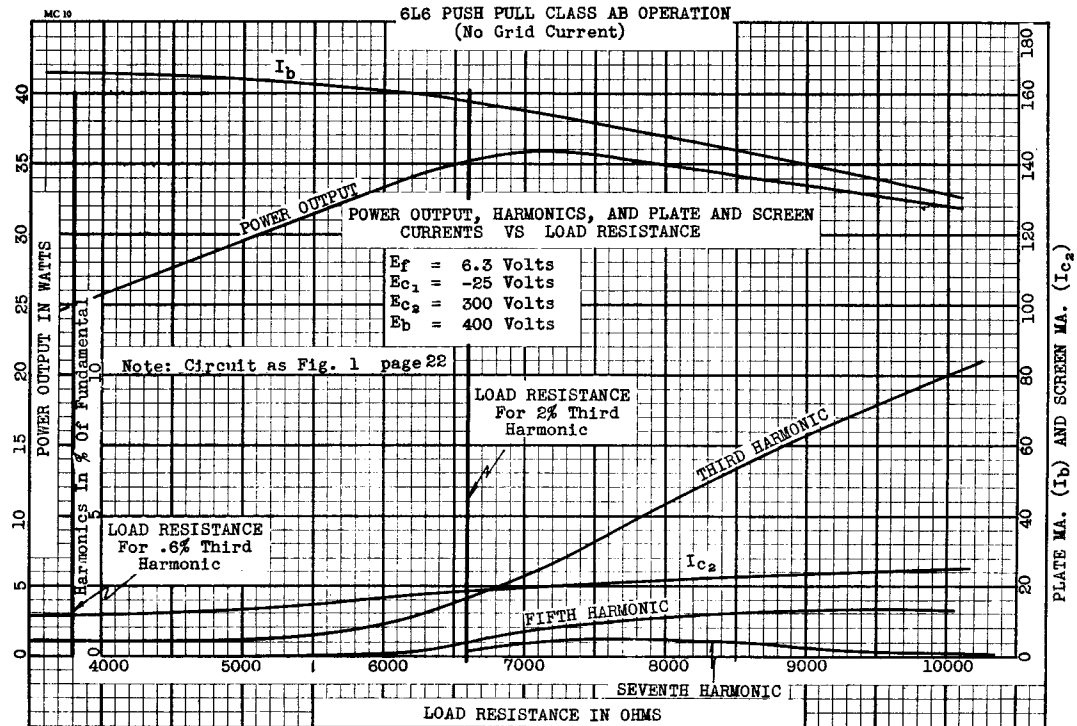

THE KEN-RAD CORPORATION
OWENSBORO, KENTUCKY

COMMERCIAL ENGINEERING DEPARTMENT

DATE 4-16-36

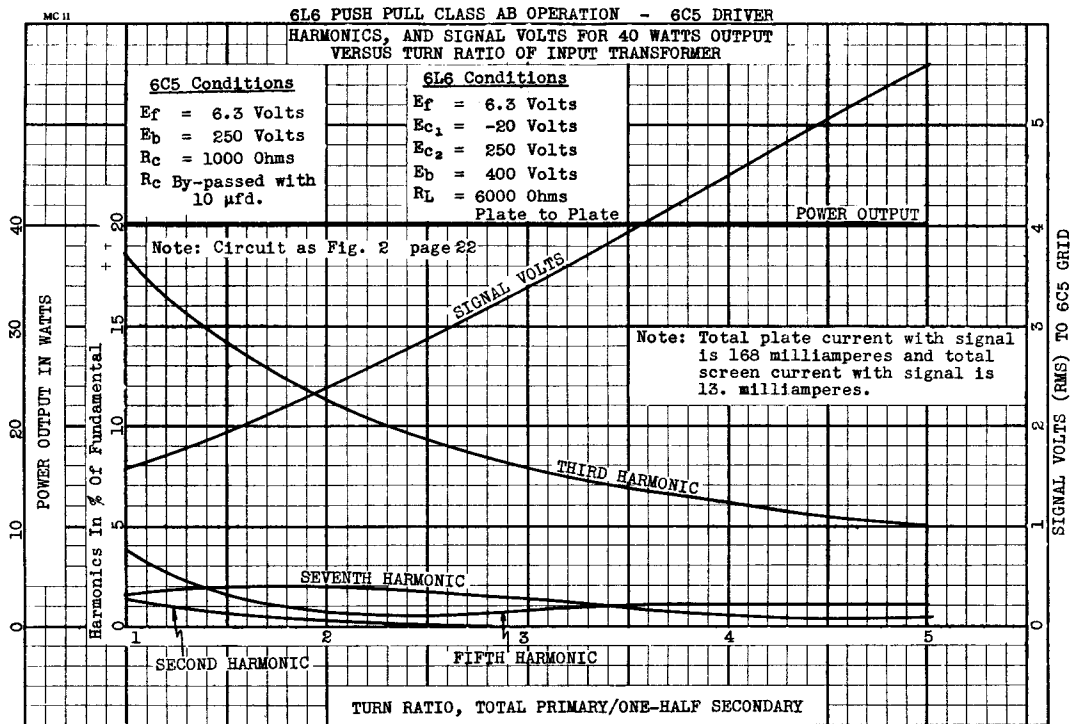

COMMERCIAL ENGINEERING DEPARTMENT

THE KEN-RAD CORPORATION
OWENSBORO, KENTUCKY

DATE 4-16-36

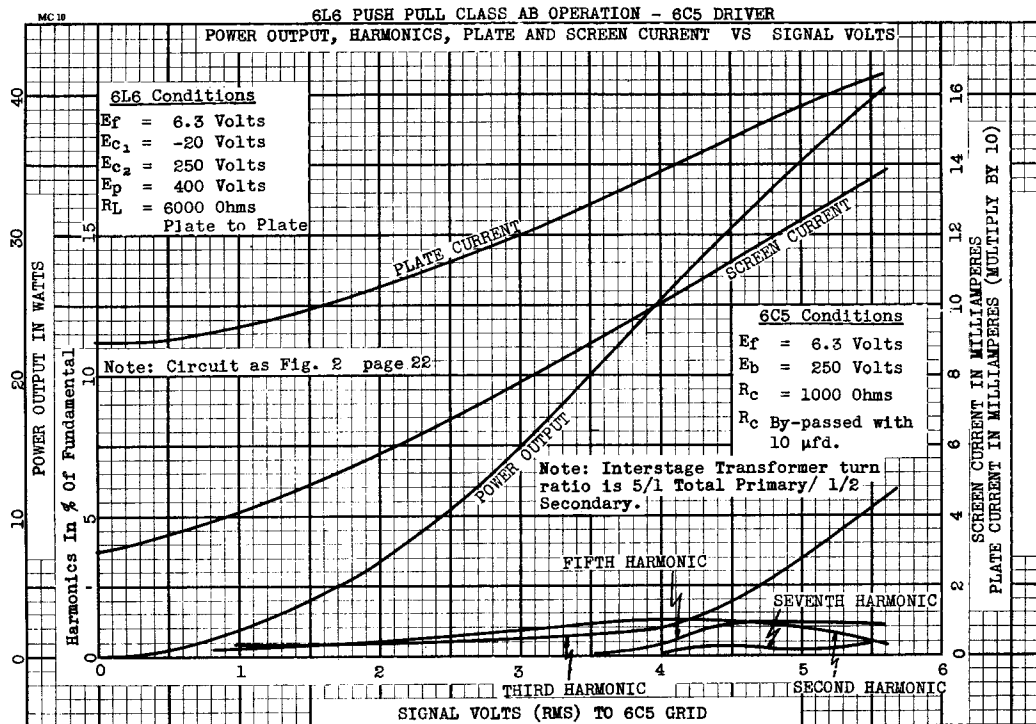

COMMERCIAL ENGINEERING DEPARTMENT

THE KEN-RAD CORPORATION
OWENSBORO, KENTUCKY

DATE 4-16-36

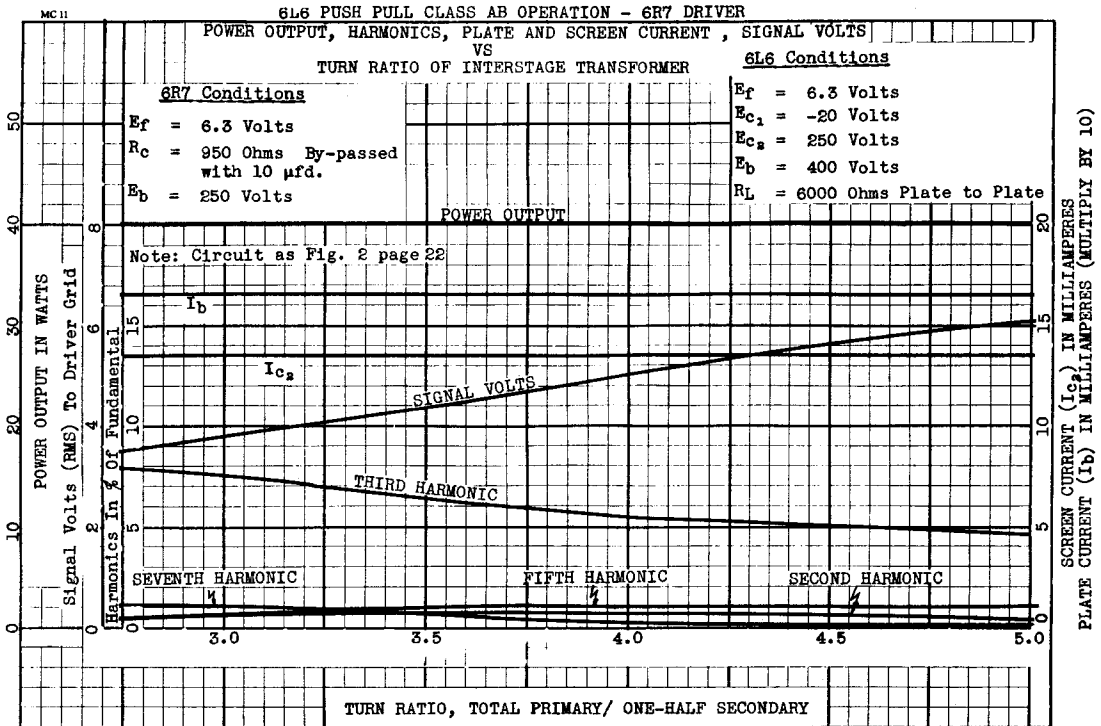

THE KEN-RAD CORPORATION
OWENSBORO, KENTUCKY

COMMERCIAL ENGINEERING DEPARTMENT

DATE 4-16-36

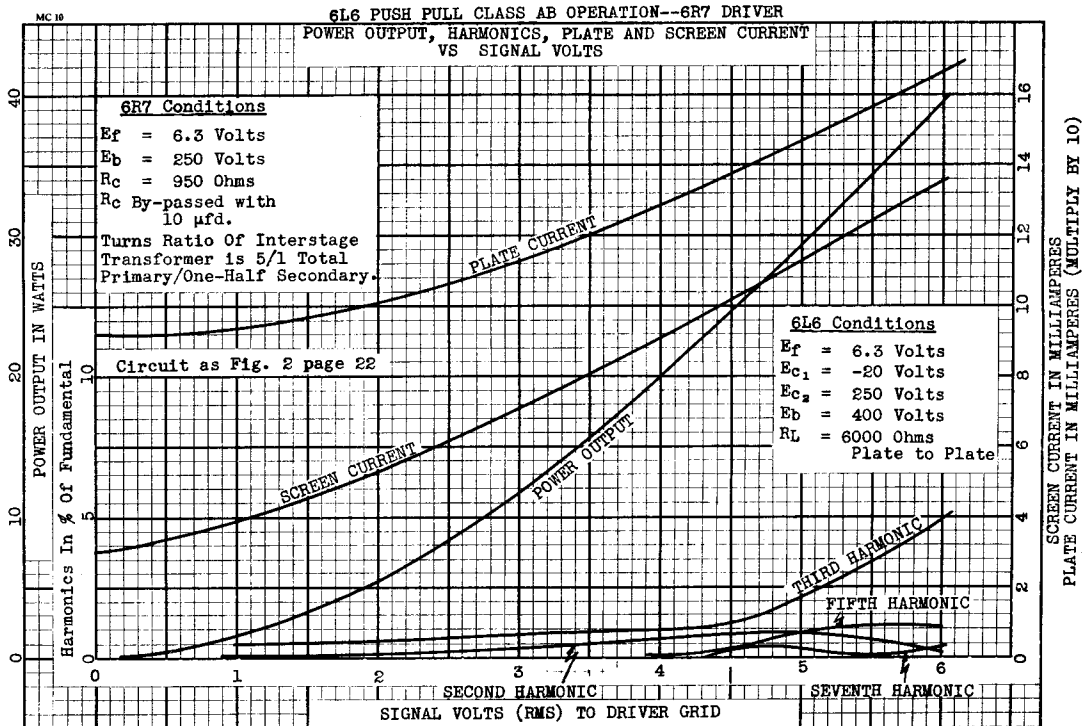

THE KEN-RAD CORPORATION
OWENSBORO, KENTUCKY

COMMERCIAL ENGINEERING DEPARTMENT

DATE 4-16-36

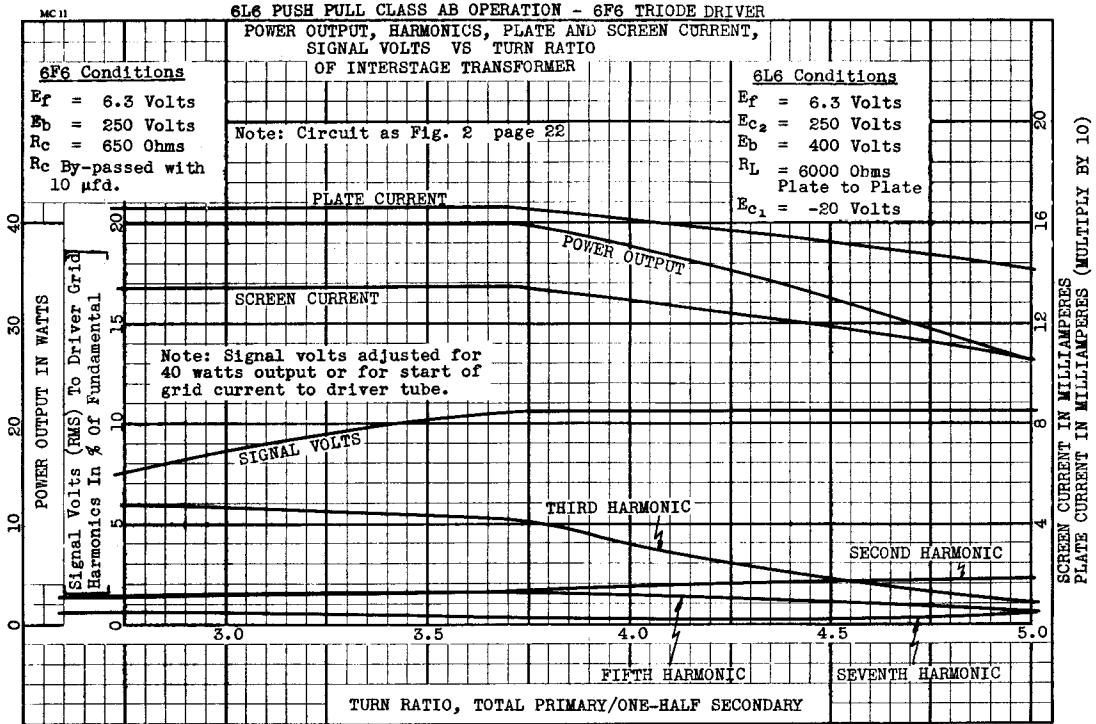

THE KEN-RAD CORPORATION
OWENSBORO, KENTUCKY

COMMERCIAL ENGINEERING DEPARTMENT

DATE 4-16-36

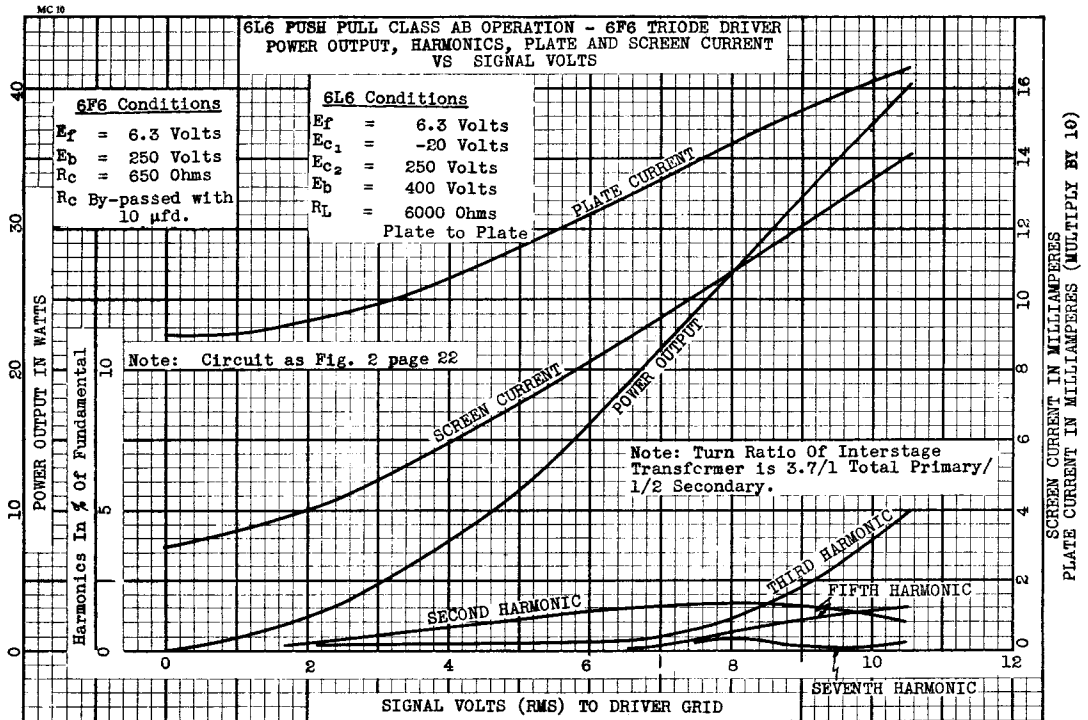

THE KEN-RAD CORPORATION
OWENSBORO, KENTUCKY

COMMERCIAL ENGINEERING DEPARTMENT

DATE 4-16-36

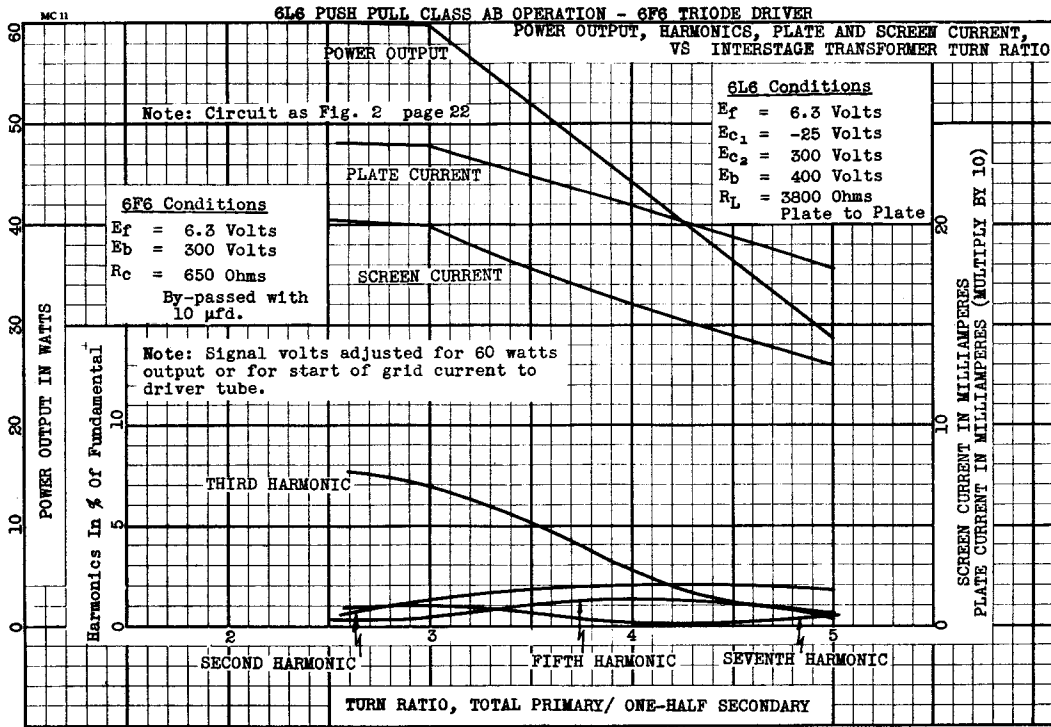

THE KEN-RAD CORPORATION
 COMMERCIAL ENGINEERING DEPARTMENT
 OWENSBORO, KENTUCKY
 DATE 4-16-36

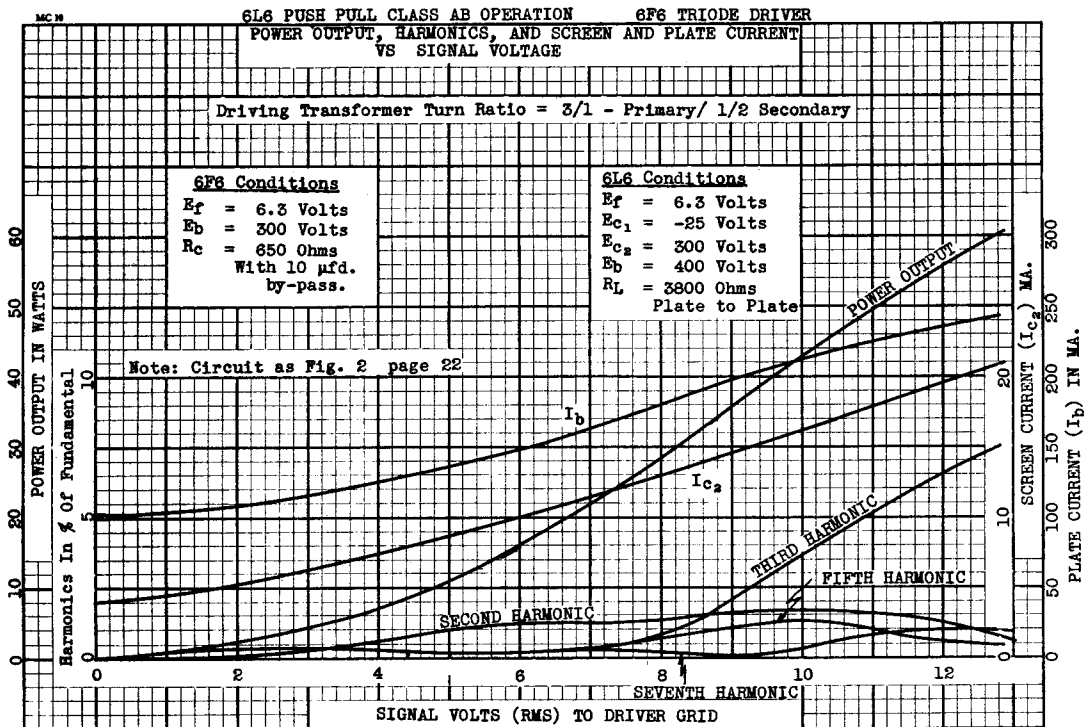

THE KEN-RAD CORPORATION
 COMMERCIAL ENGINEERING DEPARTMENT
 OWENSBORO, KENTUCKY
 DATE 4-16-36

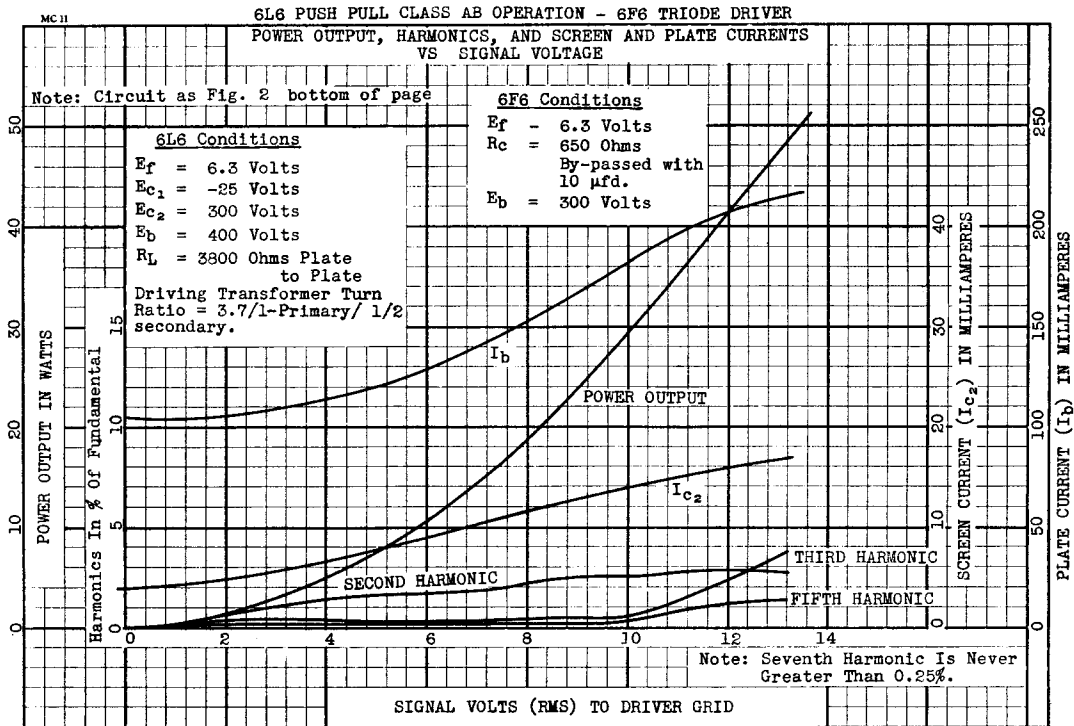

THE KEN-RAD CORPORATION
DOWNSBORO, KENTUCKY

COMMERCIAL ENGINEERING DEPARTMENT

DATE 4-16-36

CIRCUIT FOR CLASS A OPERATION AND CLASS AB OPERATION RESTRICTED TO NEGATIVE GRID REGIONS

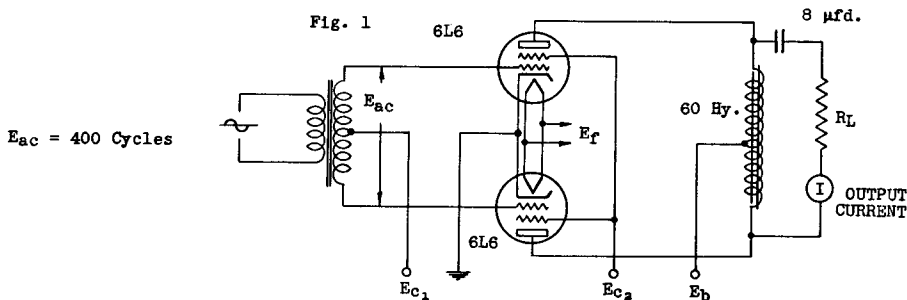

CIRCUIT FOR CLASS AB OPERATION WITH POWER DRIVERS

